

DAEWOO

USER'S MANUAL

TV RECEIVER



DSA-9310E

CUSTOMER HELPLINE NUMBER 0870 100 2525

PARTS INCLUDED IN THE BOX

Remote control

1UNIT

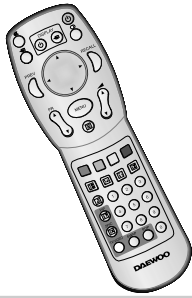

P/C Cable(optional)

1UNIT

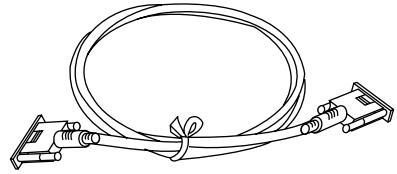





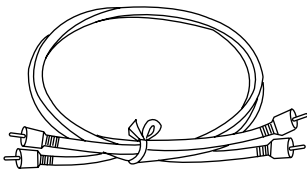















Audio Cable(optional)

1UNIT



AC Cable 1UNIT

TABLE OF CONTENTS

	PARTS INCLUDED IN THE BOX	2
	TABLE OF CONTENTS	3
	SAFETY INSTRUCTIONS	5
	FRONT & REAR VIEW OF RECEIVER	8
	FRONT PANEL	8
	REAR PANEL	9
	CONNECTION GUIDE	10
	CONNECTING WITH MONITOR	10
	CONNECTING WITH AN AERIAL	11
	CONNECTING WITH ANOTHER SET TOP BOX OR VIDEO EQUIPMENT	12
	CONNECTING WITH PC	13
	REMOTE CONTROL	14
	PROGRAMME BANNER	16
	VOLUME BAR	17
	FEATURES OF THE MAIN MENU	18
	TO START SET	20
	TO MUTE THE SOUND INSTANTLY	21
	AUTO TUNING MEMORY OF PROGRAM	22
	EDIT OF MEMORISED PROGRAM	26
	SKIPPING THE PROGRAMS POSITIONS	28
	DELETING THE PROGRAM POSITIONS	29
	MOVING THE PROGRAM POSITIONS	29
	MANUAL TUNING	30
	FINE TUNING	31
	WATCHING VIDEO PROGRAMS	32
	OPERATING PICTURE AND PICTURES	33
	PIP(PICTURE IN PICTURE)	33
	2PIC(TWIN PICTURES)	35
	POP(PICTURE OUT PICTURE)	36
	OPERATING PAP BY MENU	37
	SOUND	38
	SETTING THE CLOCK	39
	TELETEXT	40
	TROUBLE SHOOTING	42
	SPECIFICATIONS	43





SAFETY INSTRUCTIONS

Remove mains plug from socket when receiver is not in use for a long time or during a lightening storm.

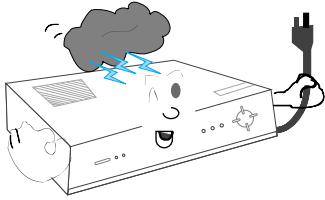

Do not place any liquid container on top of RECEIVER.

If water spills into RECEIVER, an electric short may occur which can cause a fire.

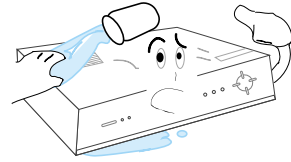

Do not handle the power cord with wet hands. Do not pull the power cord to remove the plug from the socket.

It may cause an electric shock or damage.

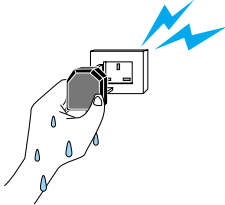

Do not overload wall outlets and extension cords. It may result in power failure.

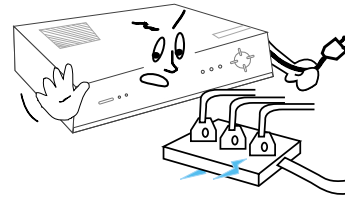

Do not make any modifications. Never attempt to disassemble the unit.

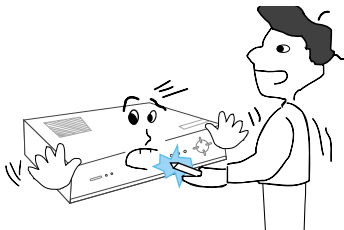

When a strange noise or smell comes from the RECEIVER, stop all operations and pull out plug. And then contact your Service agent.

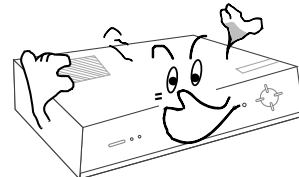



Place the RECEIVER on a plain stable surface. If not, the RECEIVER may fall off or tip over causing injury or damage.

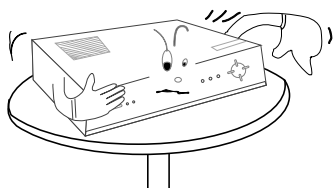

Keep the RECEIVER safe from any foreign objects.

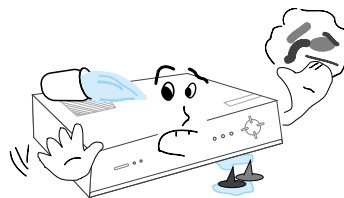

Be sure to disconnect all cables before moving RECEIVER.

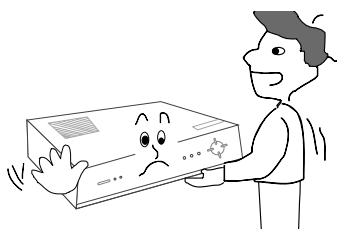

Put the RECEIVER in a place of moderate temperature 5 - 40 degrees. If not, it may cause damage or shorten the lifetime of the RECEIVER.

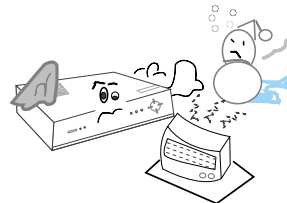

Do not put the RECEIVER in a place where it is humid or dusty, or near oil, smoke or steam.

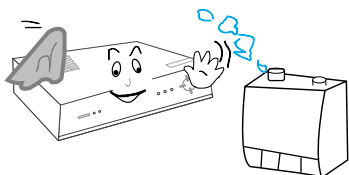

Do not lay heavy objects on the RECEIVER.

It may cause ventilation trouble, internal temperature increasing, and fire.

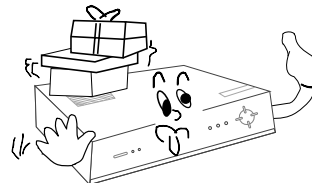

Do not use water or oil to clean.

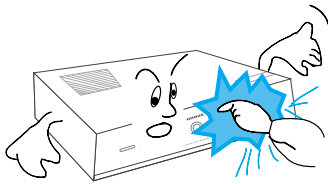

Do not put RECEIVER under the sunlight or near heating units. It may cause damage or shorten lifetime of the RECEIVER.

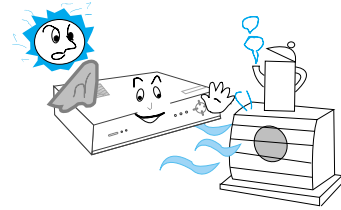

Do not press two buttons of the remote controller in at the same time. Never attempt to disassemble remote controller.

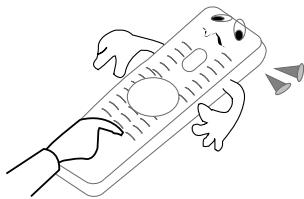

Keep the RECEIVER away from magnets or vibration.

It may cause blurred colour of screen and a damage.

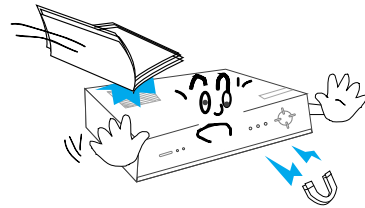

Ensure the RECEIVER is placed in a position with good ventilation.

Leave a space more than 10cm rear and 5cm side from the wall.

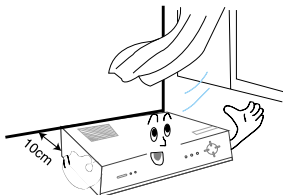

Do not plug in when the shape of socket does not match with the plug.

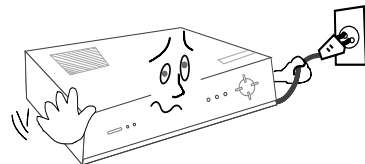

FRONT & REAR VIEW OF RECEIVER

FRONT PANEL



1. POWER BUTTON

Use to power unit on & off.

2. LED

POWER : Displays RED when the unit is powered off or standby, GREEN when the unit is powered on.

SOUND : Displays when the sound is STEREO or DUAL.

3. TV/AV BUTTON

Use to select TV/External Input MODE.

TV, AV1/2/3/4 is selected in order whenever the button is pushed.

4. MENU BUTTON

Use to access MENU option.

When The button is pressed once, MENU appears on the screen.

5. RECALL BUTTON

Use to mark a channel banner.

6. LEFT/RIGHT (◀ / ▶) BUTTON

Use to move cursor left/right in the MENU option or use to control sound volume.

7. UP/DOWN (▲ / ▼) BUTTON

Use to move cursor up/down in the MENU option or use for change channel.

REAR PANEL

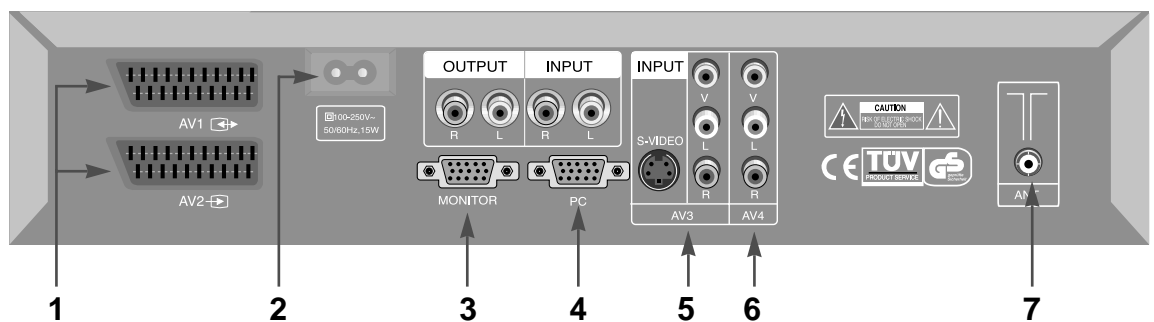

1. AV1, AV2 INPUT TERMINAL (SCART TERMINAL).

Use to connect external input such as VTR, Satellite Receiver, DVD, etc. to the RECEIVER.

2. POWER CORD CONNECTOR

Use to connect POWER CORD to the RECEIVER.

3. MONITOR / AUDIO OUTPUT TERMINAL

Use to connect MONITOR or external speaker to the RECEIVER.

4. PC INPUT / AUDIO INPUT TERMINAL

Use to connect PC input to the RECEIVER.

PC input is transferred to output terminal when the power of RECEIVER is off.

5. AV3 INPUT TERMINAL (S-VIDEO, V/L/R)

Use to connect S-VIDEO, A/V Input to the RECEIVER.

S-VIDEO input is transferred to output terminal when S-VIDEO and RCA Video input is connected to the RECEIVER at the same time.

6. A/V4 INPUT TERMINAL(V/L/R)

Use to connect A/V input to the RECEIVER.

7. ANTENNA INPUT TERMINAL

Use to connect antenna to the RECEIVER.

* This RECEIVER can receive PAL/ SECAM except PAL M/N via antenna and can receive PAL SECAM, NTSC input via external input terminal.

CONNECTION GUIDE

Connecting with Monitor

Connect D-SUB input of MONITOR to the output terminal of D-SUB output of the RECEIVER.

Connect input of speaker to audio output terminal of the RECEIVER.

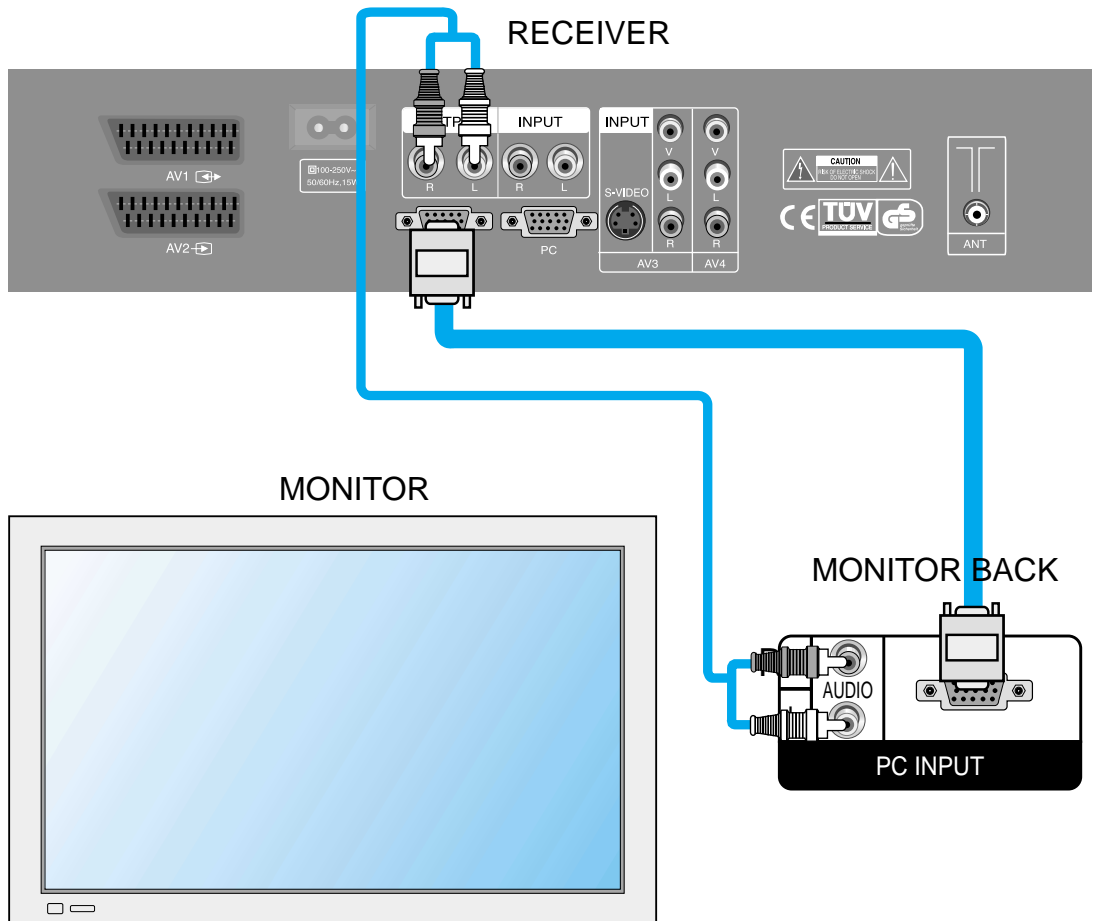



Connecting with an Aerial

Plug the aerial into the coaxial socket.

Notice

This RECEIVER can receive SECAM/PAL except PAL M/N via antenna.

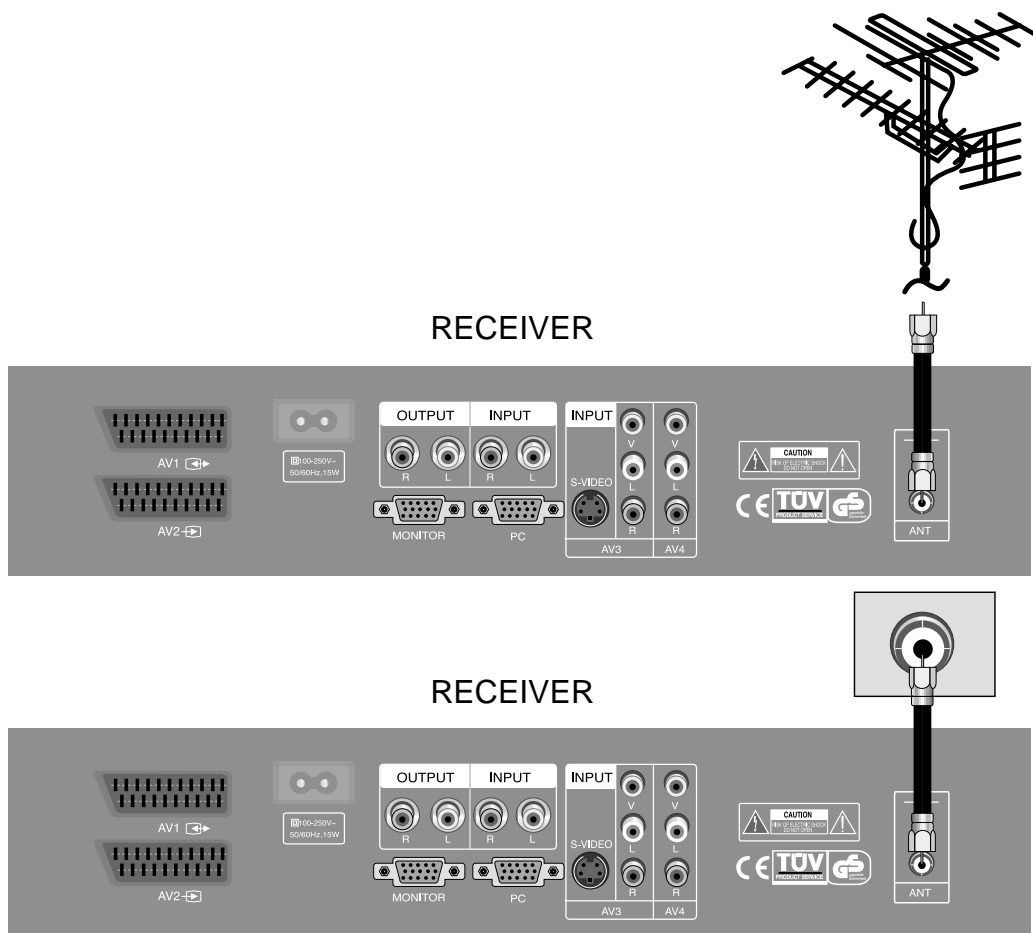

Connecting with another Set Top Box or Video Equipment

Connect output of another STB or Video equipment (SCART, A/V, S-video) to input of the RECEIVER using SCART cable, A/V cable, S-video cable.

Notice

This RECEIVER can receive SECAM/PAL/NTSC via external input.

- AV1, AV2

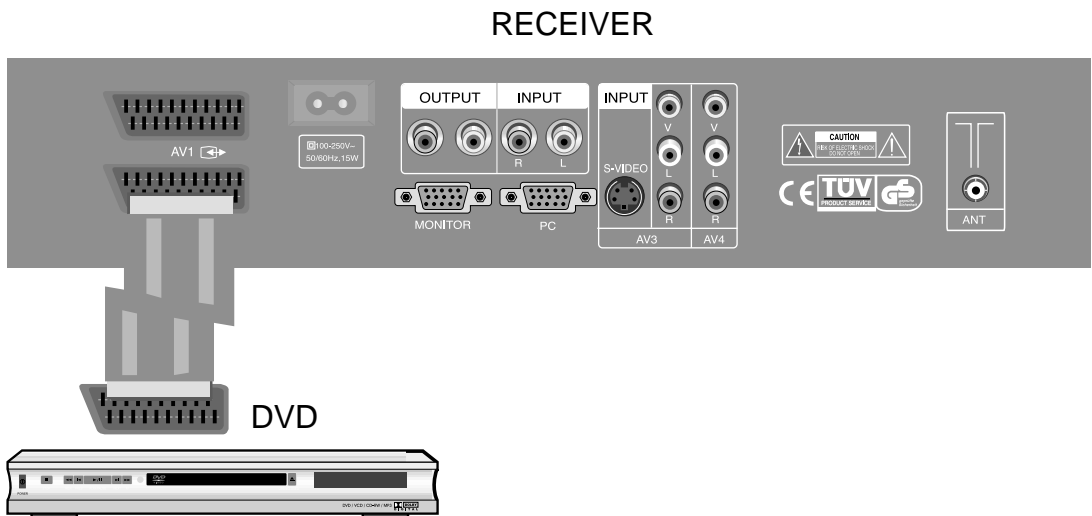

- AV3, AV4

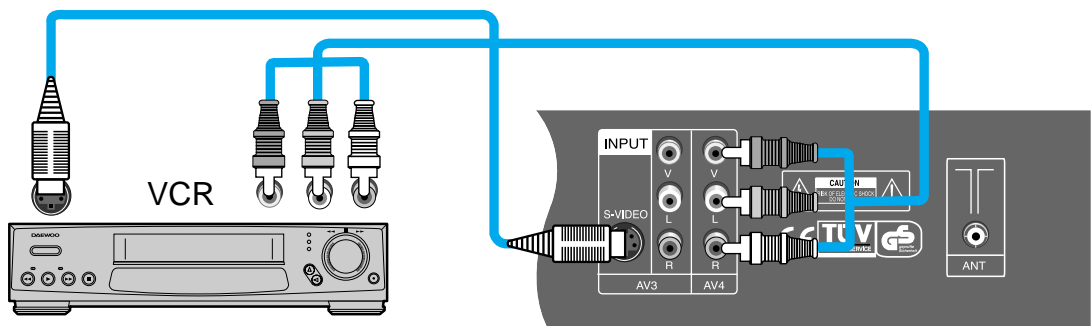



Connecting with PC

Connect PC output (D-SUB & audio output) to input of RECEIVER (D-SUB & audio input).

PC input can be outputted only when the power of RECEIVER is OFF.

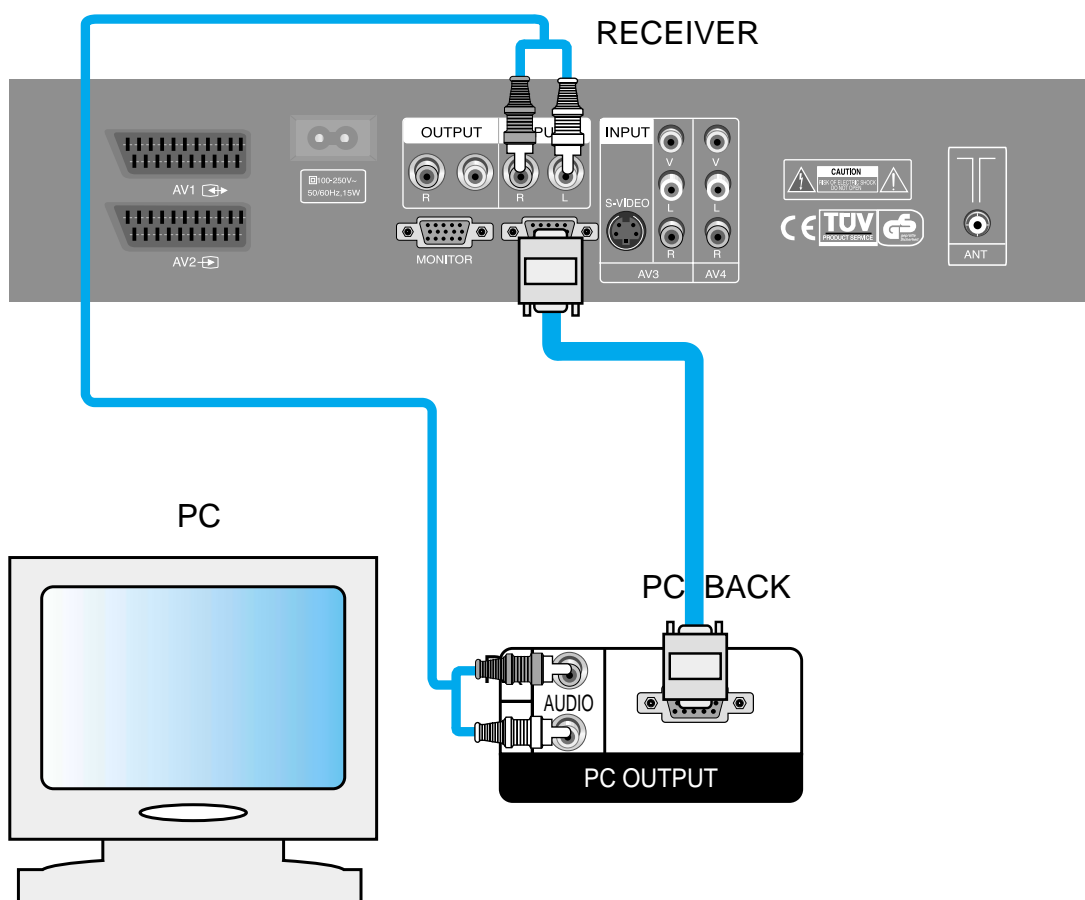

REMOTE CONTROL

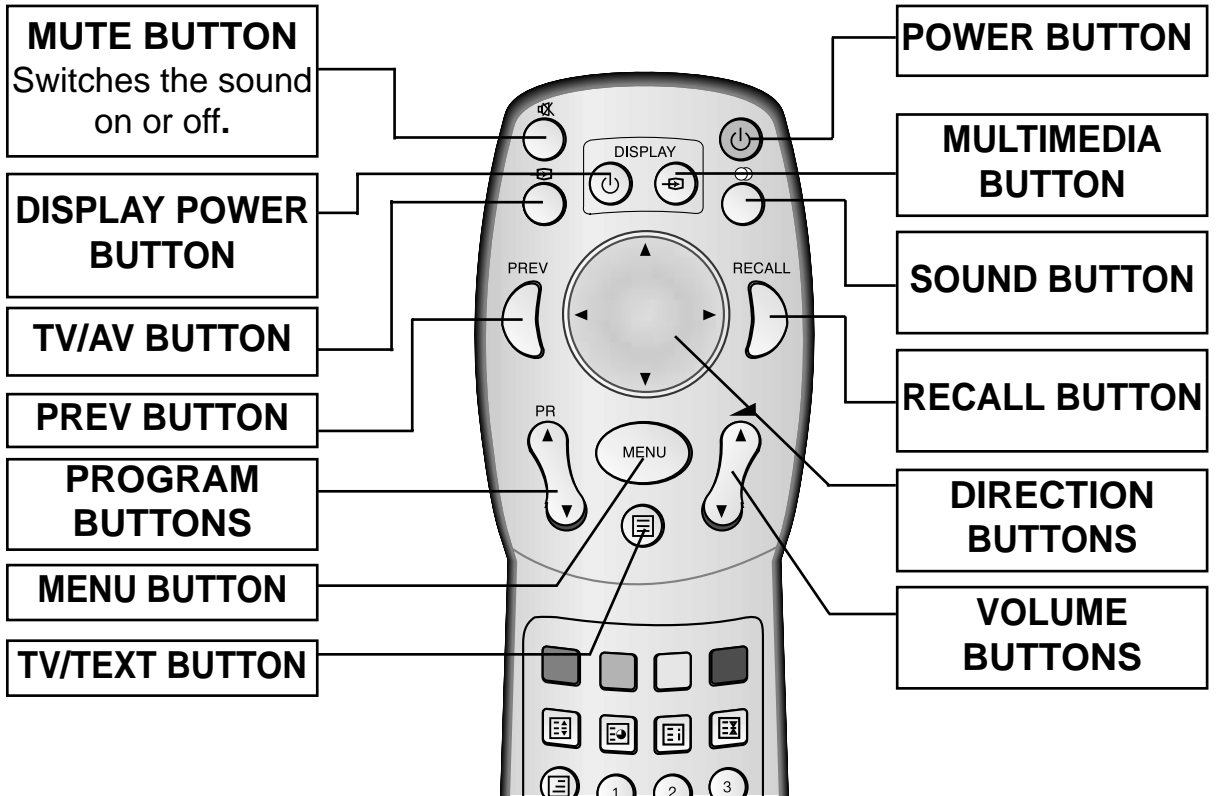

Caution

- Do not drop, avoid moisture, heat, and dust.



How to install the batteries.

- Push to open the cover of the Remote Control.
- Set the Batteries in the battery (cell), compartment after checking the polarities(+/-), and then, shut the cover(battery type "AA").

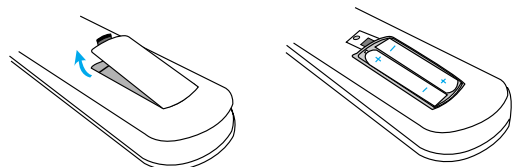

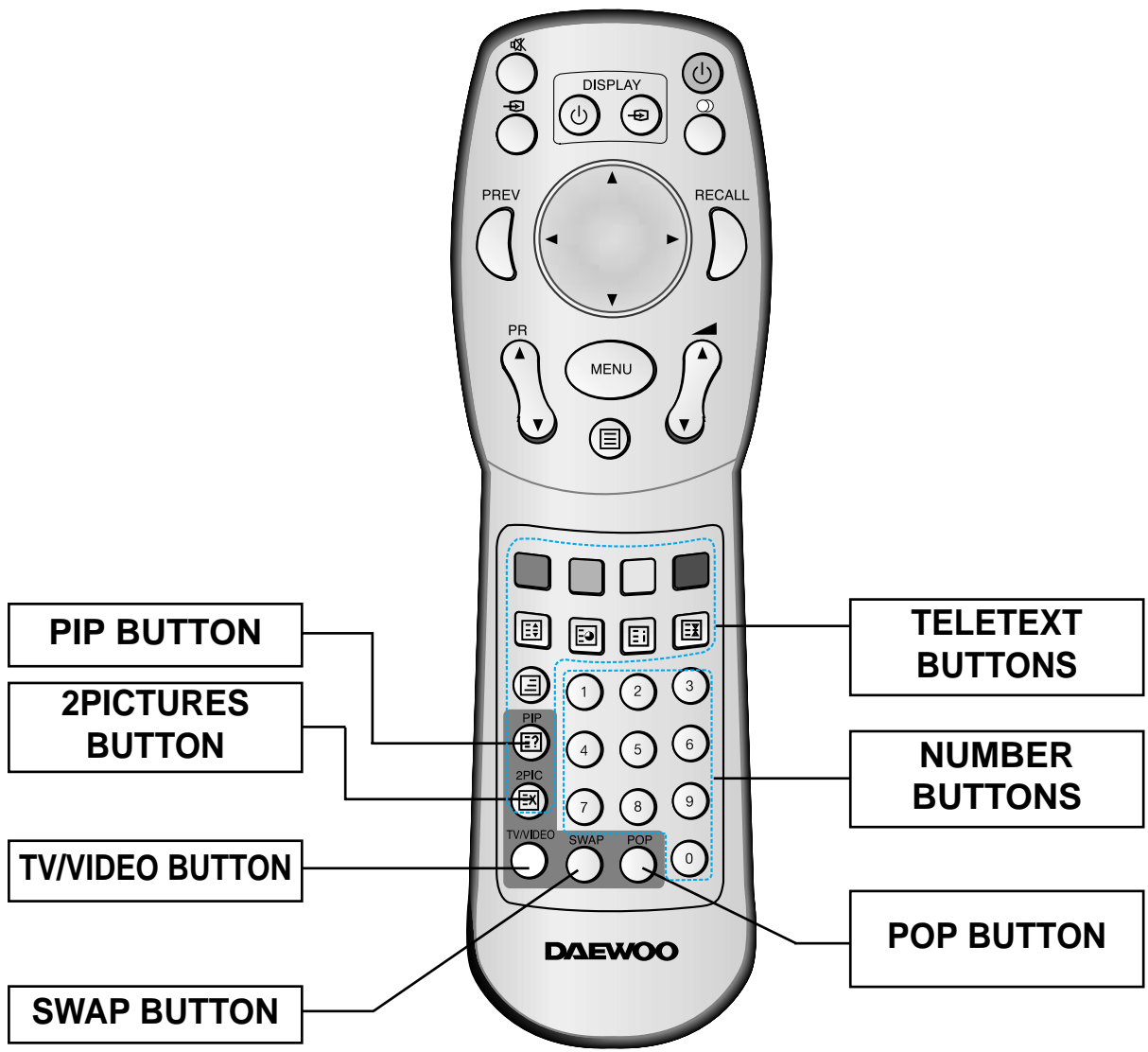

PROGRAMME BANNER





RECALL



programme Banner allows you to view the current programme information. If you press the RECALL button in normal TV viewing, the channel banner appears on the screen. Press the RECALL button once again, the programme banner disappears.

PR Number & Name Sound System Clock



Volume Bar

Volume Bar



Volume Bar allows you to control the volume ▲ / ▼.

Features of the Main Menu

MENU

Pressing the MENU button on the remote controller takes you to the “Main Menu” screen. The “Main Menu” contains four options: PIP, Timer, Install, Language. Also each option has the submenu. The option you want to select is highlighted and its submenu is displayed on the right-hand.



PAP : Screen displays and controls PIP, 2PIC, POP. Control sub picture.

Timer : Set time.

Install : Tuning menu displays and controls Edit, Auto Tuning, Manual Tuning, Fine Tuning.

Language : Displays and controls the OSD Lanugage.



Language Selection(OPTIONAL)

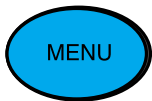

- 1** Press the MENU button to call up the Main menu.
- 2** Select the Language with ARROW ◀ / ▶ button. Then the languages will be displayed.
- 3** Press the MENU button to return to Main Menu .

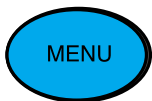
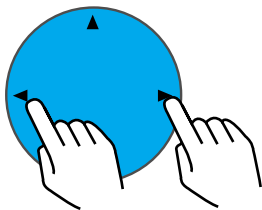

TO START SET

Notice

Buttons on the front of the set have the same functions as those of the REMOTE CONTROL.



1

Press the POWER button. The Monitor will illuminate, and the power indicator lamp will light up green.



2

Press the PR buttons. Press the PR ▲ / ▼ button or number buttons to select the Program you want.



3

Adjust the Volume. When the VOLUME ▲ / ▼ button is pressed, the volume changes.



4

Press the POWER button to turn off the set. When the set is turned off, the power indicator lamp lights up red.



TO MUTE THE SOUND INSTANTLY



This function is used when there is a phone call or a visitor. Press the MUTE button, to stop the sound of the program

- When this button is pressed, the sound goes off with word Mute Icon displayed on the Monitor.
- Press it again, and the sound returns.

AUTO TUNING MEMORY OF PROGRAM

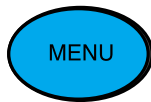
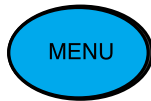

- Actual broadcasting channels can be set up in the “Memory” of the set through this function. With auto Tuning, desired channels can be selected easily with PR ▲ / ▼ buttons. Such inconvenience as pressing PR Numbers one by one is not necessary.
- MENU mode automatically disappears in several seconds when there is no button operation. If you want to get out of the MENU mode yourself, press MENU button several times.

1 Press the MENU Button.





- 2** Select Install.
- Move the cursor by ARROW ▲ / ▼ buttons.
 - Select Install sub-menu by using ARROW ► button.

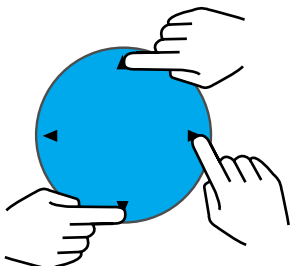

- 3** Select “Auto Tuning”
- Select country by ARROW ◀ / ▶ buttons.
 - Select “Auto Tuning” sub-menu by using ARROW ▲ / ▼ button.

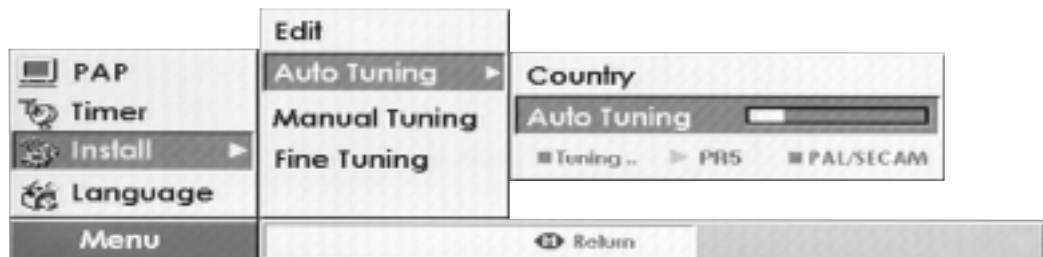



4 Select "Auto Tuning"
 · Start tuning by ARROW ► button.

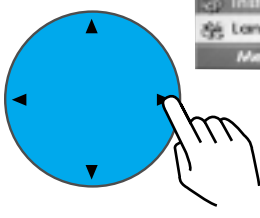
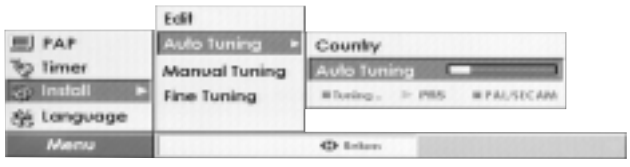

Notice

The Country menu allows you to select your local station before channel tuning.

- Europe : PAL/SECAM → SECAM-L.
- East Europe : PAL/SECAM.
- Deutschland : PAL/SECAM.
- Great Britain : PAL/SECAM(UHF only).
- France : SECAM-L → PAL/SECAM.
- Ireland : PAL/SECAM.

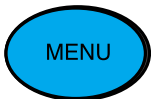

- 5** When the Auto Tuning is completed, “edit Mode” appears on the Monitor.
- Edit mode disappears automatically in several seconds or Pressing MENU button.

Edit		PROG.	NAME	SETP	SOUND
PAP	Auto Tuning	PR 06:	-----	NO	AUTO
Timer	Manual Tuning	PR 07:	-----	NO	AUTO
Install	Fine Tuning	PR 08:	-----	NO	AUTO
Language		PR 09:	-----	NO	AUTO
		PR 10:	-----	NO	AUTO
		PR 11:	-----	NO	AUTO
		PR 12:	-----	NO	AUTO

Menu ▲▼ Access ◀▶ Position ↻ Return ⏭ Skip ⏮ Move ☐ Delete



- 6** Check the memorised status by pressing PR ▲ / ▼ buttons.
- Only memorised channels are selected.

EDIT OF MEMORISED PROGRAM

- The change is memorised automatically.



Notice

The EDIT menu shows you information as follows :

- Program position assignment : PR number and Station name.
- Skip information : YES, NO
- Sound information : Auto, B/G, I, D/K1, D/K2, D/K3, L.

- 1 Select EDIT at the Tuning Menu.

	Edit	PR NO.	NAME	SKIP	SOUND
PAP	Auto Tuning	PR 06:	-----	NO	AUTO
Timer	Manual Tuning	PR 07:	-----	NO	AUTO
Install	Fine Tuning	PR 08:	-----	NO	AUTO
Language		PR 09:	-----	NO	AUTO
		PR 10:	-----	NO	AUTO
		PR 11:	-----	NO	AUTO
		PR 12:	-----	NO	AUTO

Menu ▲▼ Access ◀▶ Position ◂ Return ⏭ Skip ⏮ Move ⏪ Delete



2 After Moving the cursor by ARROW ◀ / ▶ buttons, select the information by ARROW ▲ / ▼ button.

Ex) ENTER A STATION NAME

- Move the cursor to Name.
- You can enter a station name with the ▲ / ▼ buttons. A letter from the Alphabet and Numbers will appear one-by-one.

PR



3 Check the Edit status by pressing PR ▲ / ▼ buttons.”
· The edit status appears in the PR banner.

SKIPPING THE PROGRAMS



The programme marked with SKIP “YES” is skipped when changing channel using the PR ▲ / ▼ buttons. A skipped program number can be selected using the NUMBER button 0..9, These will be displayed in Red.

· Select SKIP “YES” or “NO” with the “SKIP (Red)” button.

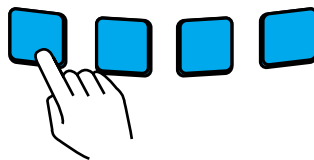

· You can also use the ARROW ▲ / ▼ buttons after moving the cursor to Skip.





DELETING THE PROGRAM POSITIONS

- Position the selection bar to program number to delete with the ▲ / ▼ buttons.
- Press the “DELETE (Yellow)” button.

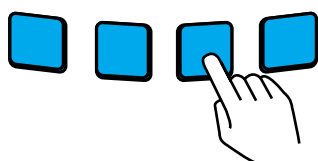

MOVING THE PROGRAM POSITIONS

- Position the selection bar to program number you want to move.
- Press the “MOVE (Green)” button. The colour of selection bar will be changed to Green.
- Position the new selection bar to new program number.
- Press the MOVE (Green) button.

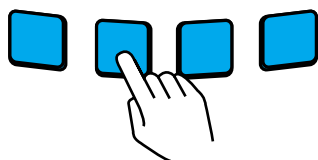

MANUAL TUNING

- If you are unable to get any programs because of a poor broadcasting signal, it is possible to store the Manual tuning.



- 1 Select manual tuning at the Install menu.



- 2 Press the Arrow ◀ / ▶ Buttons.
 - A Tuning bar will move from left to right / from right to left.
 - After searching a station, the tuning Bar will stop. If you want to stop tuning, press the MENU button.

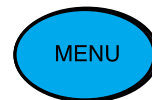
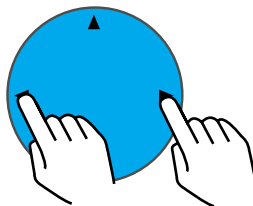



- 3 Select programme number using the ▲ / ▼ buttons and Press the “Green” button to store.

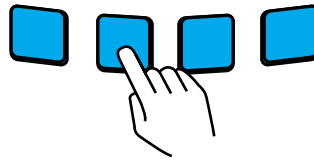
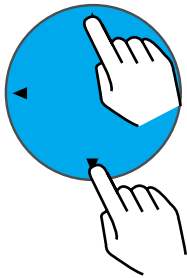

FINE TUNING

- If you are unable to get a good picture or sound because of a poor broadcasting signal, it is possible to adjust the fine tuning.
- The change is memorised automatically.

- 1 Select “Fine Tuning”.

- 2 Press ARROW ◀ / ▶ buttons to activate fine tuning up or down.

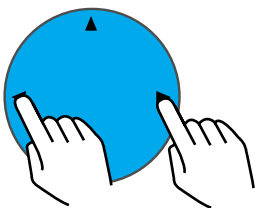

WATCHING VIDEO PROGRAMS

Notice

S-VIDEO takes precedence if S-VIDEO is connected to AV3.



1

Connect the video cable to the VIDEO socket at the back of set, and press AV Button on the remote control and on the Front.

- The screen changes to video mode as follows:
- Whenever this button is pressed, the screen shifts in sequence :
PR → AV1 → AV2 → AV3 → AV4 → PR.

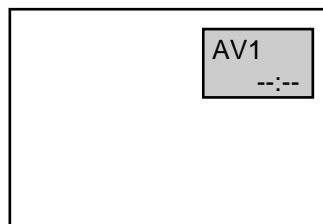

OPERATING PICTURE AND PICTURE

Notice

- The sound of the set is available only in the main program window(the left one).
- The same PRs or the two video programs can not be operated in both windows of the screen.
- Every time SWAP button is pressed, the Pictures alternate.



PIP (PICTURE IN PICTURE)

You can enjoy two window programs at the same time. Along with the main window program, you can have another TV channel program or a Video program simultaneously.



1 Press PIP Button

- Single PIP appears on the picture left top.

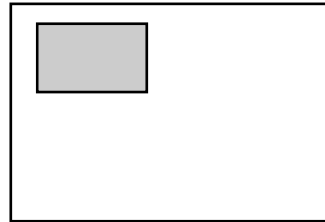

PR



2 Select a programme you want to watch in the auxiliary window.

- Select a programme you want to watch in the auxiliary window by using ARROW ▲ / ▼ buttons on the Remote Control.

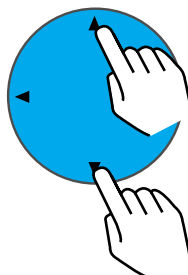



3 Select Video Program in the auxiliary window.

· To operate VIDEO program in the auxiliary window, connect the video cable to the VIDEO IN socket at the back of SET, and press TV/VIDEO button on the auxiliary window control panel area on the Remote Control.

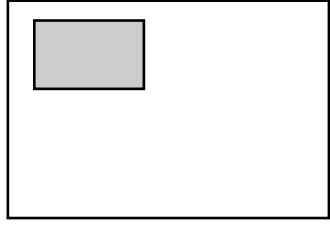

4 Select Position of the auxiliary window.

· Select Position you want to display the auxiliary window by using ARROW ◀ / ▶ buttons on the Remote Control.

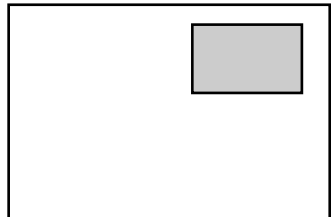
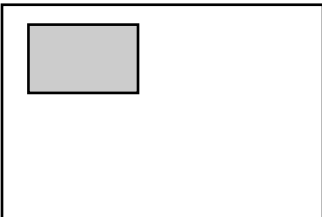
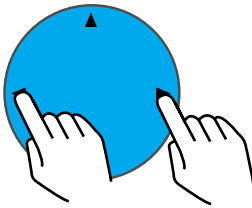

5 Press PIP Button again, and the auxiliary window disappears.





2PIC (Twin Pictures)

· You can enjoy two window programs at the same time. Along with the main window program, you can have another TV channel program or a Video program simultaneously.



1 Press 2PIC Button
· The operating program window becomes the main window and moves to the left side of the screen, an auxiliary window appears on the right side at the same time.



2 Select a programme you want to watch, Select Video Program in the auxiliary window.
· The function is identical with the PIP function.



3 Press 2PIC Button again, and the auxiliary window disappears.



POP (Picture Out Picture)

Five windows appear on the screen. Memorised programmes are connected one-by-one to each auxiliary window in sequence. Thus, it is easy to check the contents of the programs on air.



1

Press POP Button

- Four auxiliary window appears on the picture Right.

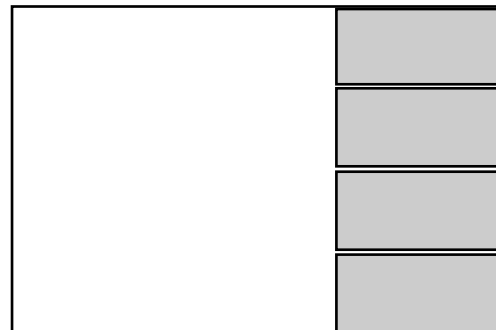

2

Press POP Button again, and the auxiliary window disappears.

OPERATING PAP BY MENU

Notice

Functions on the Menu have the same functions as those of the REMOTE CONTROL.

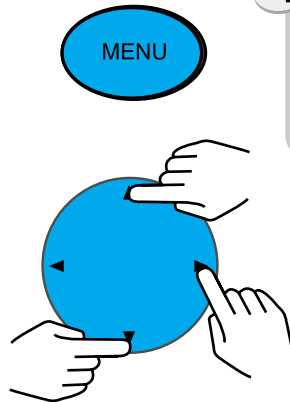

- 1 Press Menu Button, Select PAP.
 - Move the cursor by ARROW ▲ / ▼ buttons.
 - Select PAP sub-menu by using ARROW ► button.



- 2 Select "On" PAP on the sub-menu using right hand arrow.
 - Move the cursor by ARROW ▲ / ▼ buttons.
 - Select items by ARROW ◀ / ▶ buttons.

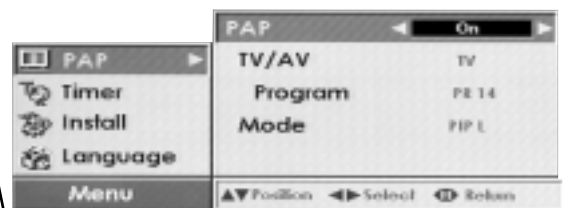

Notice

- PAP : On/Off
- TV/AV : Select Video Program in the auxiliary window.
- Program : Select a PR you want in the auxiliary window.
- MODE : Select a PAP mode.
(PIP L, PIP R, 2PIC, POP)

SOUND

- There may be cases of stereo broadcasts where excessive noise will be heard due to weak incoming signal. You may be able to eliminate this noise by selecting the MONO mode.



During a stereo Program transmission

- 1** Press the Sound (🔊) button.
It will change to MONO from STEREO.
Then the Banner OSD will be changed to MONO.
- 2** Press the Sound (🔊) button again
It will change it back to stereo.

During a bilingual programme transmission

- 1** Press the Sound (🔊) button.
It will change the language to the second channel (DUAL SUB).
- 2** Press again will change it back to the main channel (DUAL MAIN).

SETTING THE CLOCK

Notice

If you turn the set off with MAIN POWER, the clock setting is lost and must be reset if necessary.



- 1 Press the MENU Button, Select "Timer"

MENU



- 2 Manually clock setting and collection
 - Set "HOUR" by "ARROW" ◀ button and, MIN by Arrow ▶.
- 3 Automatic clock setting and correction
 - Even though you turn the set off with MAIN POWER, if you select a program of your country which has Teletext or PDC transmission, clock will be set and corrected automatically.
- 4 Check the Clock by pressing RECALL buttons.
 - The Clock and the PR banner will appear for a few seconds.

Notice

This function is only available for the countries as follows :
Deutschland, Great Britain, France, Italy, Sweden, Switzerland, Netherlands, Ireland.

TELETEXT

SWITCHING TELETEXT ON/OFF

Press the TEXT button(Ⓜ).

The index page or the page viewed last will appear.

Press the TEXT button(Ⓜ) again to return to the TV mode.

COLOUR BUTTONS IN TOP/FLOF TELETEXT

A red(■), green(□), yellow(□) and blue(■) field is shown at the bottom of the screen.

If TOP or FLOF Teletext is transmitted by the station, pressing the corresponding colour button on the remote controller, you can select the desired page easily.

SELECTING PAGES

The NUMBER button 0..9 are used to enter a page number.

The selected page number appears at the top of the screen and the page appears after a short time.

The ▲ / ▼ buttons increase or decrease the current page number by 1.

INDEX PAGE

You can switch directly to the programme preview(with TOP text) or the overview

page of the station you are currently viewing by pressing the INDEX(Ⓜ) button.

PAGE HOLD

Several sub pages can be combined under a page number and are scrolled at an interval determined by the television station.

The presence of sub pages is indicated by, for example, 3/6 beneath the time, which means that you are looking at the 3rd page of a total of 6 pages.

If you want to look at a subpage for a longer period of time, press the HOLD (Ⓜ) button.

The “ stop ! “ appears beside page number and the contents of the subpage shown are kept on the screen and no longer updated or switched to other subpages.



Pressing the HOLD button(Ⓜ) again, the current subpage appear.



CALLING UP SUBPAGE DIRECTLY

Pressing the SUBPAGE() button , “ sub-code - - - - “ appears beside page number.

Enter the subpage number that you want to call up with the NUMBER button 0..9 ,for example, the 2nd page, sequence 0002.

The desired subpage will eventually be displayed on the screen and holds it there. Meanwhile whilst you are waiting, it is possible to go back to the TV picture by pressing the CANCEL button() on the remote and after a while, press the CANCEL button() again to revert back to the saved text sub page.

WATCHING TELEVISION DURING TELETEXT MODE

Some pages are continually updated, for example, stock market reports, sports announcements, and the latest news.

If you want to watch television and stay informed at the same time, press CANCEL () button.

The regular programme is still visible and the teletext page number appears at the top of the screen.

Pressing the CANCEL button(), the teletext page appears with the updated information.

REVEAL ANSWER

This function can be used on certain pages to reveal the solution of riddles. Press the REVEAL button () to reveal a hidden answer and press again to hide it.

DOUBLING CHARACTER SIZE

Repeatedly pressing the SIZE button () doubles the character size in the following order:

Upper half of the page -> Lower half of the page -> Return to normal size.

TROUBLE SHOOTING

- Most problems are possible to solve by checking basic settings. Please check the following settings prior to calling the Daewoo Electronics Service Centre for assistance.

SYMPTOM	SOLUTION
It is not powering on	<ul style="list-style-type: none"> · Check to see if the power cord is plugged in securely.
Can not change to a specific programme with PR ▲ / ▼ button.	<ul style="list-style-type: none"> · Check the programme mode by pressing the RECALL button. · It's possible that the channel may not have been memorised and stored correctly.
Picture Quality is poor.	<ul style="list-style-type: none"> · Check the FINE TUNING.
Remote control doesn't work	<ul style="list-style-type: none"> · Check for batteries. Change batteries if the charge has been depleted. · Use remote control within 23feet of the remote sensor. · Remove all hindrances between remote sensor and remote control.

SPECIFICATION

MODEL NO.	DSA-9310E
System	PAL, SECAM-B/G, D/K, PAL-I/I, SECAM-L/L, NTSC-3.58Mhz(External Input)
Rated Voltage	AC 100-250V , 50/60Hz
POWER Consumption	15 W
Dimension	350 x 73 x 258.5 mm
Number of Program	100 Programs

· The appearance and specification of this product can change without notice for product modification.